

Project Cover Page

Project Name			
Primary Material		Secondary Material	
Type Name	Sheet Good Not Specified	Type Name	Sheet Good Not Specified
Project default banding material			
Primary	Not Specified	Secondary	Not Specified
B.O.M. Rounding Method		Layout Diagram Settings	
Round up costs to the next whole board or sheet		Layouts are drawn to scale	
Optimization Settings			
Primary Objective	Minimize total cost.		
CutList Plus Silver Edition (fx 18.0.2)			
Notes			

Parts List

[x]	Part #	Sub-Assembly	Description	Copies	# Cut	Thick	Width	Length	Material Type	Material Name	Banding	<Info>	Diagram #s
[]	1		20003-01	1	0	1/2"	48"	78"	Sheet Good	15/32" (1/2") A/C or CDX Plywood	None		B12
[]	2		20003-02	1	0	1/2"	48"	40"	Sheet Good	15/32" (1/2") A/C or CDX Plywood	None		B11
[]	3		20003-03	1	0	1/2"	48"	40"	Sheet Good	15/32" (1/2") A/C or CDX Plywood	None		B11
[]	4		20003-07	4	0	1/2"	28 3/4"	37"	Sheet Good	15/32" (1/2") A/C or CDX Plywood	None		B5, B8
[]	5		20003-10	4	0	1/2"	12"	12"	Sheet Good	15/32" (1/2") A/C or CDX Plywood	None		B2, B11
[]	6		20004-25	32	0	1/2"	6 9/16"	8 1/4"	Sheet Good	15/32" (1/2") A/C or CDX Plywood	None		B4, B6, B8, B9, B10, ...
[]	7		20004-26	8	0	1/2"	11 11/16"	46 1/2"	Sheet Good	15/32" (1/2") A/C or CDX Plywood	None		B7, B10
[]	8		20004-35	8	0	1/2"	12 3/8"	55 1/2"	Sheet Good	15/32" (1/2") A/C or CDX Plywood	None		B1, B2, B6, B9
[]	9		20004-36	16	0	1/2"	12"	33"	Sheet Good	15/32" (1/2") A/C or CDX Plywood	None		B1, B6, B7, B9
[]	10		20004-41	8	0	1/2"	22"	36"	Sheet Good	15/32" (1/2") A/C or CDX Plywood	None		B3, B4, B8
[]	11		20004-42	4	0	1/2"	12"	48"	Sheet Good	15/32" (1/2") A/C or CDX Plywood	None		B7
[]	12		20004-06	4	0	1/2"	3"	14"	Sheet Good	15/32" (1/2") A/C or CDX Plywood	None		B8, B9, B10
[]	13		20004-05	4	0	1/2"	8 1/16"	12 7/8"	Sheet Good	15/32" (1/2") A/C or CDX Plywood	None		B5, B10, B12
[]	14		20004-07	4	0	1/2"	10 1/16"	12"	Sheet Good	15/32" (1/2") A/C or CDX Plywood	None		B3, B6, B8
[]	15		20004-08	4	0	1/2"	12 11/16"	16 1/2"	Sheet Good	15/32" (1/2") A/C or CDX Plywood	None		B11, B12

[X]	Part #	Sub-Assembly	Description	Copies	# Cut	Thick	Width	Length	Material	Type	Material Name	Banding	<Info>	Diagram #s
[]	16		20004-04	2	0	1/2"	6 1/2"	26 5/8"	Sheet	Good	15/32" (1/2") A/C or CDX Plywood	None		B2, B7
[]	17		20004-11	2	0	1/2"	12"	23 5/8"	Sheet	Good	15/32" (1/2") A/C or CDX Plywood	None		B5, B10
[]	18		20001-01	1	0	1/2"	30"	55"	Sheet	Good	15/32" (1/2") A/C or CDX Plywood	None		B2
[]	19		20001-02	2	0	1/2"	30"	30"	Sheet	Good	15/32" (1/2") A/C or CDX Plywood	None		B2, B5
[]	20		20000-01	1	0	1/2"	45 1/2"	68"	Sheet	Good	15/32" (1/2") A/C or CDX Plywood	None		B3
[]	21		20000-03	4	0	1/2"	18"	18"	Sheet	Good	15/32" (1/2") A/C or CDX Plywood	None		B1, B5
[]	48		20002-01	2	0	1/4"	32"	32"	Sheet	Good	1/4" Plywood	None		A1
[]	22		20003-04	8	0	1 1/2"	3 1/2"	48"	Dimensioned Lumber		2"x 4" Pine lumber	N/A		C21
[]	23		20003-05	4	0	1 1/2"	3 1/2"	75"	Dimensioned Lumber		2"x 4" Pine lumber	N/A		C8
[]	24		20003-06	4	0	1 1/2"	3 1/2"	37"	Dimensioned Lumber		2"x 4" Pine lumber	N/A		C2
[]	25		20003-11	2	0	1 1/2"	3 1/2"	43"	Dimensioned Lumber		2"x 4" Pine lumber	N/A		C10
[]	26		20004-27	4	0	1 1/2"	3 1/2"	13 1/8"	Dimensioned Lumber		2"x 4" Pine lumber	N/A		C8
[]	27		20004-28	8	0	1 1/2"	3 1/2"	47 3/4"	Dimensioned Lumber		2"x 4" Pine lumber	N/A		C21
[]	28		20004-29	4	0	1 1/2"	3 1/2"	46 1/2"	Dimensioned Lumber		2"x 4" Pine lumber	N/A		C12
[]	29		20004-30	4	0	1 1/2"	3 1/2"	24 11/16"	Dimensioned Lumber		2"x 4" Pine lumber	N/A		C6, C9, C13
[]	30		20004-37	4	0	1 1/2"	3 1/2"	92 1/2"	Dimensioned Lumber		2"x 4" Pine lumber	N/A		C11
[]	31		20004-38	8	0	1 1/2"	3 1/2"	64 9/16"	Dimensioned Lumber		2"x 4" Pine lumber	N/A		C9, C17, C18

[X]	Part #	Sub-Assembly	Description	Copies	# Cut	Thick	Width	Length	Material Type	Material Name	Banding	<Info>	Diagram #s
[]	32		20004-39	4	0	1 1/2"	3 1/2"	47 5/8"	Dimensioned Lumber	2"x 4" Pine lumber	N/A		C19
[]	33		20004-24	6	0	1 1/2"	3 1/2"	84"	Dimensioned Lumber	2"x 4" Pine lumber	N/A		C5, C15, C16
[]	34		20004-16	4	0	1 1/2"	3 1/2"	5 1/4"	Dimensioned Lumber	2"x 4" Pine lumber	N/A		C16
[]	35		20004-18	4	0	1 1/2"	3 1/2"	4 3/4"	Dimensioned Lumber	2"x 4" Pine lumber	N/A		C15
[]	36		20004-17	4	0	1 1/2"	3 1/2"	38 1/4"	Dimensioned Lumber	2"x 4" Pine lumber	N/A		C3, C14
[]	37		20004-12	4	0	1 1/2"	3 1/2"	71 9/16"	Dimensioned Lumber	2"x 4" Pine lumber	N/A		C20
[]	38		20004-15	2	0	1 1/2"	3 1/2"	43"	Dimensioned Lumber	2"x 4" Pine lumber	N/A		C7
[]	39		20004-13	2	0	1 1/2"	3 1/2"	49 1/2"	Dimensioned Lumber	2"x 4" Pine lumber	N/A		C10
[]	40		20001-06	2	0	1 1/2"	3 1/2"	23"	Dimensioned Lumber	2"x 4" Pine lumber	N/A		C13
[]	41		20001-03	2	0	1 1/2"	3 1/2"	55"	Dimensioned Lumber	2"x 4" Pine lumber	N/A		C14
[]	42		20001-04	2	0	1 1/2"	3 1/2"	30"	Dimensioned Lumber	2"x 4" Pine lumber	N/A		C17
[]	43		20001-07	4	0	1 1/2"	3 1/2"	22 1/2"	Dimensioned Lumber	2"x 4" Pine lumber	N/A		C1, C13
[]	44		20001-05	4	0	1 1/2"	3 1/2"	30"	Dimensioned Lumber	2"x 4" Pine lumber	N/A		C18
[]	45		20000-02	4	0	1 1/2"	3 1/2"	24"	Dimensioned Lumber	2"x 4" Pine lumber	N/A		C20
[]	46		20000-04	1	0	1 1/2"	3 1/2"	60"	Dimensioned Lumber	2"x 4" Pine lumber	N/A		C6
[]	47		20004-14	2	0	1 1/2"	3 1/2"	41"	Dimensioned Lumber	2"x 4" Pine lumber	N/A		C4

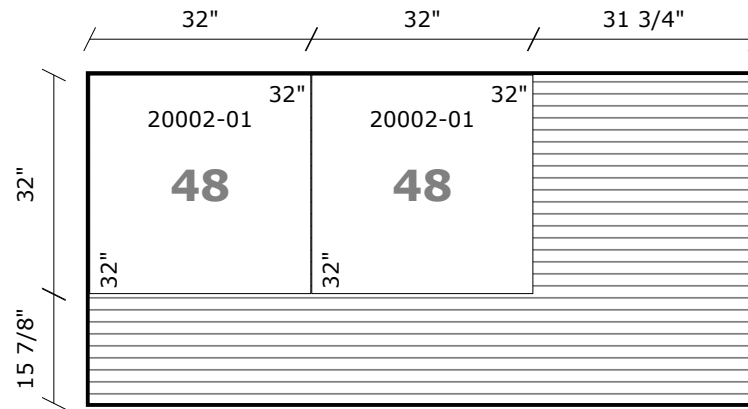

[A1] 1/4" Plywood: 1/4" x 48" x 96"

Vendor: Bin:

[] 1 of 1 this size

Qty this diag.: 1

Grain: Horizontal

Stock Trim: 0"::0"

Standard Layout

Kerf: 1/8"

Part Padding: 0"

Waste: 55.6%

Final Cut Dimensions

Part #	Sub-Assembly	Description	Copies in Layout	Thick	Final Cut Y	Final Cut X	Rough Y	Rough X	Banding	<Info>
48		20002-01	2	1/4"	32"	32"	32"	32"	None	

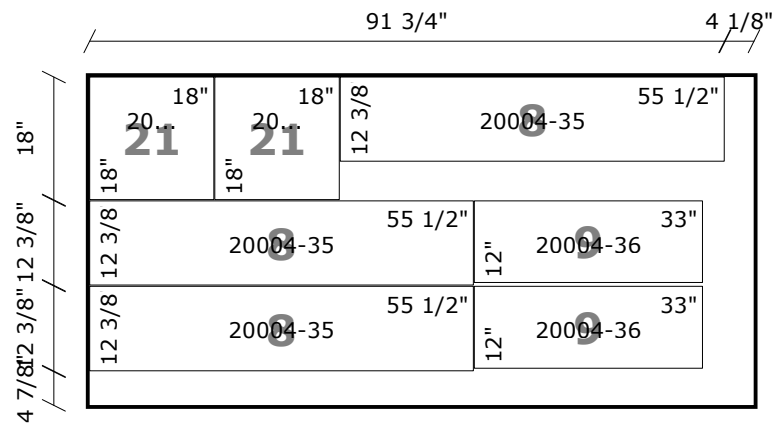

[B1] 15/32" (1/2") A/C or CDX Plywood: 1/2" x 48" x 96"

Vendor: Bin:

[] 1 of 12 this size		Qty this diag.: 1	Grain: None	Stock Trim: 0"::0"	Standard Layout
Kerf: 1/8"	Part Padding: 0"	Waste: 24.0%		Final Cut Dimensions	

Part #	Sub-Assembly	Description	Copies in Layout	Thick	Final Cut Y	Final Cut X	Rough Y	Rough X	Banding	<Info>
8		20004-35	3	1/2"	12 3/8"	55 1/2"	12 3/8"	55 1/2"	None	
9		20004-36	2	1/2"	12"	33"	12"	33"	None	
21		20000-03	2	1/2"	18"	18"	18"	18"	None	

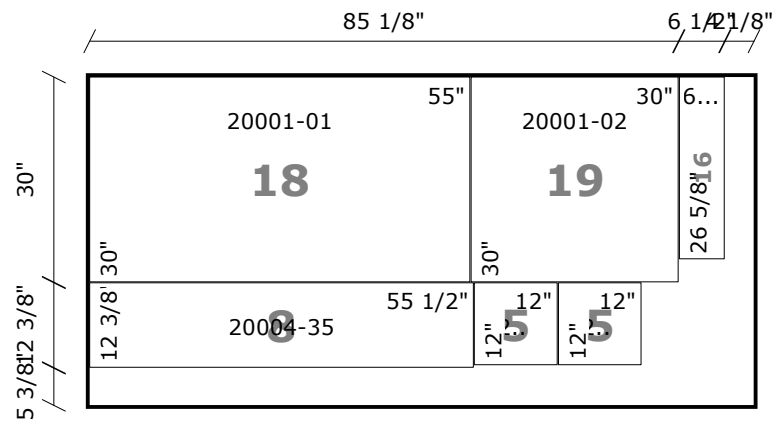

[B2] 15/32" (1/2") A/C or CDX Plywood: 1/2" x 48" x 96"

Vendor: Bin:

[] 2 of 12 this size	Qty this diag.: 1	Grain: None	Stock Trim: 0"::0"	Standard Layout
Kerf: 1/8"	Part Padding: 0"	Waste: 19.8%	Final Cut Dimensions	

Part #	Sub-Assembly	Description	Copies in Layout	Thick	Final Cut Y	Final Cut X	Rough Y	Rough X	Banding	<Info>
5		20003-10	2	1/2"	12"	12"	12"	12"	None	
8		20004-35	1	1/2"	12 3/8"	55 1/2"	12 3/8"	55 1/2"	None	
16[R]		20004-04	1	1/2"	26 5/8"	6 1/2"	26 5/8"	6 1/2"	None	
18		20001-01	1	1/2"	30"	55"	30"	55"	None	
19		20001-02	1	1/2"	30"	30"	30"	30"	None	

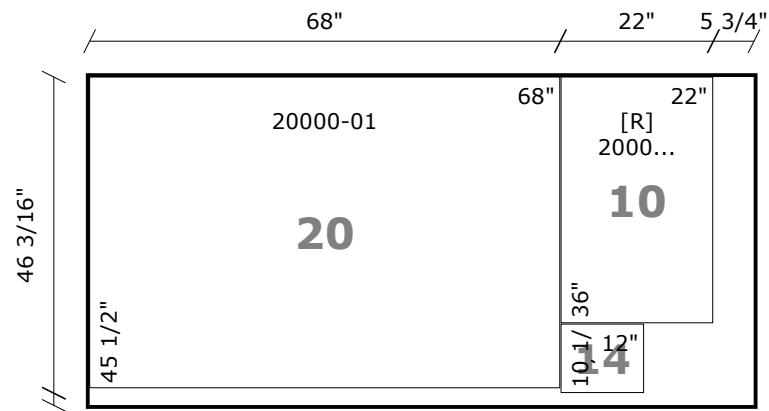

[B3] 15/32" (1/2") A/C or CDX Plywood: 1/2" x 48" x 96"

Vendor: Bin:

[] 3 of 12 this size

Qty this diag.: 1

Grain: None

Stock Trim: 0"::0"

Standard Layout

Kerf: 1/8"

Part Padding: 0"

Waste: 13.0%

Final Cut Dimensions

Part #	Sub-Assembly	Description	Copies in Layout	Thick	Final Cut Y	Final Cut X	Rough Y	Rough X	Banding	<Info>
10[R]		20004-41	1	1/2"	36"	22"	36"	22"	None	
14		20004-07	1	1/2"	10 1/16"	12"	10 1/16"	12"	None	
20		20000-01	1	1/2"	45 1/2"	68"	45 1/2"	68"	None	

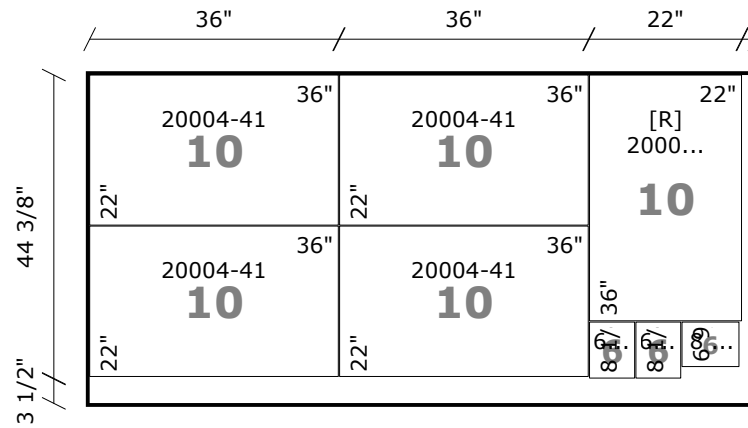

[B4] 15/32" (1/2") A/C or CDX Plywood: 1/2" x 48" x 96"

Vendor: Bin:

[] 4 of 12 this size

Qty this diag.: 1

Grain: None

Stock Trim: 0"::0"

Standard Layout

Kerf: 1/8"

Part Padding: 0"

Waste: 10.5%

Final Cut Dimensions

Part #	Sub-Assembly	Description	Copies in Layout	Thick	Final Cut Y	Final Cut X	Rough Y	Rough X	Banding	<Info>
6[R]		20004-25	2	1/2"	8 1/4"	6 9/16"	8 1/4"	6 9/16"	None	
6		20004-25	1	1/2"	6 9/16"	8 1/4"	6 9/16"	8 1/4"	None	
10		20004-41	4	1/2"	22"	36"	22"	36"	None	
10[R]		20004-41	1	1/2"	36"	22"	36"	22"	None	

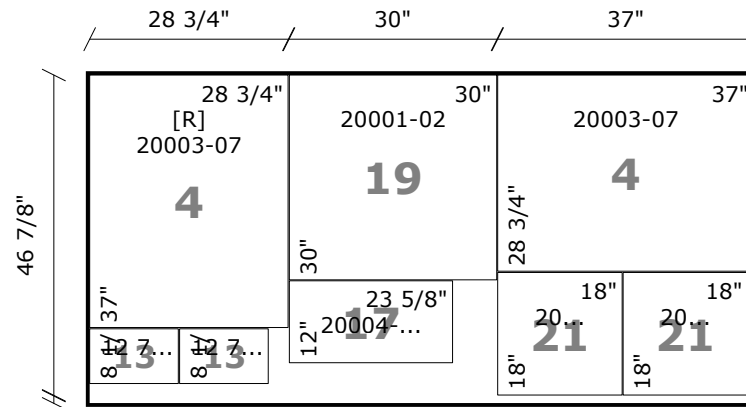

[B5] 15/32" (1/2") A/C or CDX Plywood: 1/2" x 48" x 96"

Vendor: Bin:

[] 5 of 12 this size

Qty this diag.: 1

Grain: None

Stock Trim: 0"::0"

Standard Layout

Kerf: 1/8"

Part Padding: 0"

Waste: 9.6%

Final Cut Dimensions

Part #	Sub-Assembly	Description	Copies in Layout	Thick	Final Cut Y	Final Cut X	Rough Y	Rough X	Banding	<Info>
4[R]		20003-07	1	1/2"	37"	28 3/4"	37"	28 3/4"	None	
4		20003-07	1	1/2"	28 3/4"	37"	28 3/4"	37"	None	
13		20004-05	2	1/2"	8 1/16"	12 7/8"	8 1/16"	12 7/8"	None	
17		20004-11	1	1/2"	12"	23 5/8"	12"	23 5/8"	None	
19		20001-02	1	1/2"	30"	30"	30"	30"	None	
21		20000-03	2	1/2"	18"	18"	18"	18"	None	

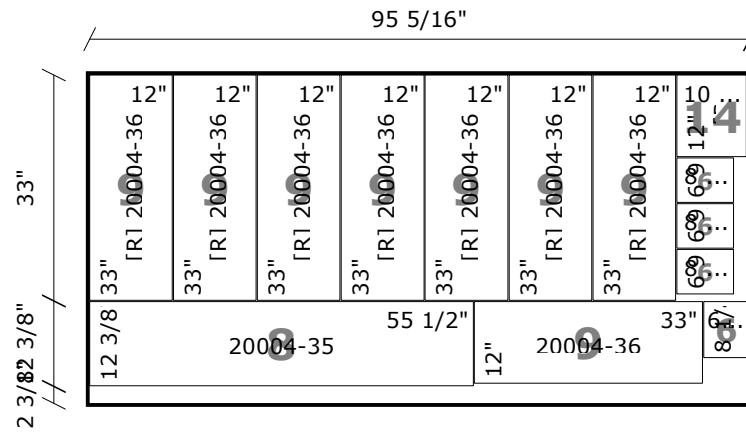

[B6] 15/32" (1/2") A/C or CDX Plywood: 1/2" x 48" x 96"

Vendor: Bin:

[] 6 of 12 this size

Qty this diag.: 1

Grain: None

Stock Trim: 0"::0"

Standard Layout

Kerf: 1/8"

Part Padding: 0"

Waste: 9.0%

Final Cut Dimensions

Part #	Sub-Assembly	Description	Copies in Layout	Thick	Final Cut Y	Final Cut X	Rough Y	Rough X	Banding	<Info>
6[R]		20004-25	1	1/2"	8 1/4"	6 9/16"	8 1/4"	6 9/16"	None	
6		20004-25	3	1/2"	6 9/16"	8 1/4"	6 9/16"	8 1/4"	None	
8		20004-35	1	1/2"	12 3/8"	55 1/2"	12 3/8"	55 1/2"	None	
9[R]		20004-36	7	1/2"	33"	12"	33"	12"	None	
9		20004-36	1	1/2"	12"	33"	12"	33"	None	
14[R]		20004-07	1	1/2"	12"	10 1/16"	12"	10 1/16"	None	

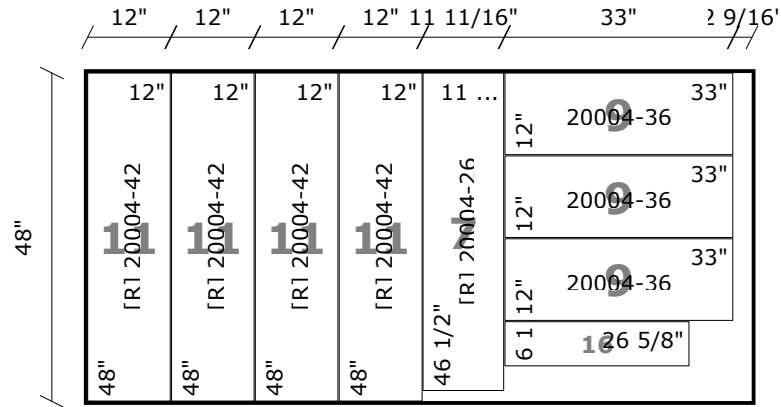

[B7] 15/32" (1/2") A/C or CDX Plywood: 1/2" x 48" x 96"

Vendor: Bin:

[] 7 of 12 this size

Qty this diag.: 1

Grain: None

Stock Trim: 0"::0"

Standard Layout

Kerf: 1/8"

Part Padding: 0"

Waste: 8.7%

Final Cut Dimensions

Part #	Sub-Assembly	Description	Copies in Layout	Thick	Final Cut Y	Final Cut X	Rough Y	Rough X	Banding	<Info>
7[R]		20004-26	1	1/2"	46 1/2"	11 11/16"	46 1/2"	11 11/16"	None	
9		20004-36	3	1/2"	12"	33"	12"	33"	None	
11[R]		20004-42	4	1/2"	48"	12"	48"	12"	None	
16		20004-04	1	1/2"	6 1/2"	26 5/8"	6 1/2"	26 5/8"	None	

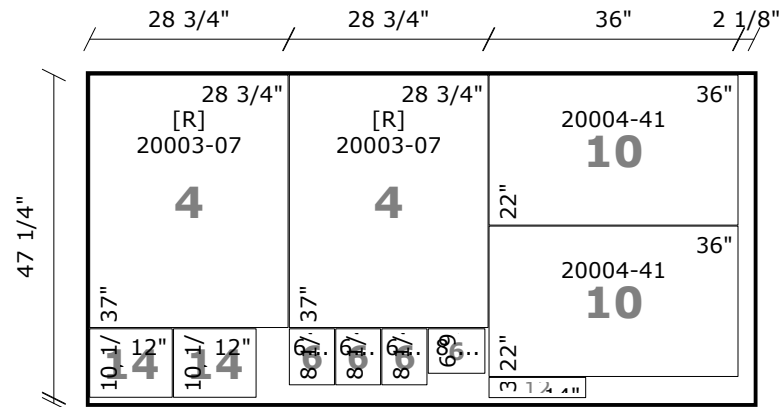

[B8] 15/32" (1/2") A/C or CDX Plywood: 1/2" x 48" x 96"

Vendor: Bin:

[] 8 of 12 this size Qty this diag.: 1 Grain: None Stock Trim: 0"::0" Standard Layout

Kerf: 1/8" Part Padding: 0" Waste: 8.6% Final Cut Dimensions

Part #	Sub-Assembly	Description	Copies in Layout	Thick	Final Cut Y	Final Cut X	Rough Y	Rough X	Banding	<Info>
4[R]		20003-07	2	1/2"	37"	28 3/4"	37"	28 3/4"	None	
6[R]		20004-25	3	1/2"	8 1/4"	6 9/16"	8 1/4"	6 9/16"	None	
6		20004-25	1	1/2"	6 9/16"	8 1/4"	6 9/16"	8 1/4"	None	
10		20004-41	2	1/2"	22"	36"	22"	36"	None	
12		20004-06	1	1/2"	3"	14"	3"	14"	None	
14		20004-07	2	1/2"	10 1/16"	12"	10 1/16"	12"	None	

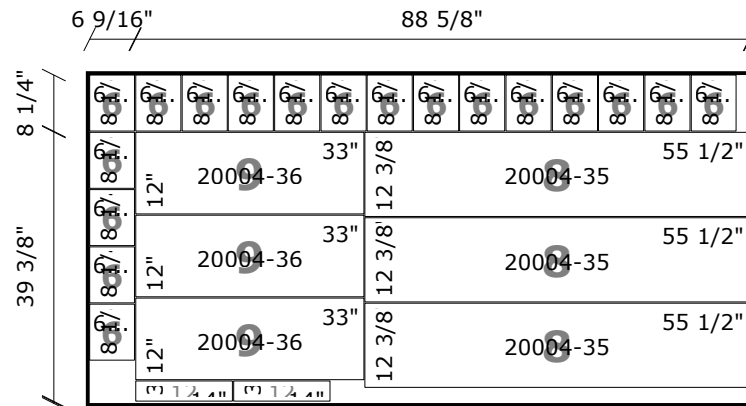

[B9] 15/32" (1/2") A/C or CDX Plywood: 1/2" x 48" x 96"

Vendor: Bin:

[] 9 of 12 this size

Qty this diag.: 1

Grain: None

Stock Trim: 0"::0"

Standard Layout

Kerf: 1/8"

Part Padding: 0"

Waste: 6.5%

Final Cut Dimensions

Part #	Sub-Assembly	Description	Copies in Layout	Thick	Final Cut Y	Final Cut X	Rough Y	Rough X	Banding	<Info>
6[R]		20004-25	18	1/2"	8 1/4"	6 9/16"	8 1/4"	6 9/16"	None	
8		20004-35	3	1/2"	12 3/8"	55 1/2"	12 3/8"	55 1/2"	None	
9		20004-36	3	1/2"	12"	33"	12"	33"	None	
12		20004-06	2	1/2"	3"	14"	3"	14"	None	

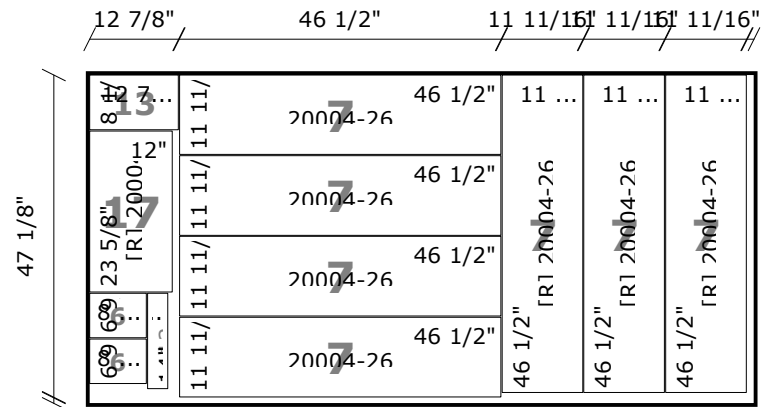

[B10] 15/32" (1/2") A/C or CDX Plywood: 1/2" x 48" x 96"

Vendor: Bin:

[] 10 of 12 this size	Qty this diag.: 1	Grain: None	Stock Trim: 0"::0"	Standard Layout
Kerf: 1/8"	Part Padding: 0"	Waste: 5.8%	Final Cut Dimensions	

Part #	Sub-Assembly	Description	Copies in Layout	Thick	Final Cut Y	Final Cut X	Rough Y	Rough X	Banding	<Info>
6		20004-25	2	1/2"	6 9/16"	8 1/4"	6 9/16"	8 1/4"	None	
7		20004-26	4	1/2"	11 11/16"	46 1/2"	11 11/16"	46 1/2"	None	
7[R]		20004-26	3	1/2"	46 1/2"	11 11/16"	46 1/2"	11 11/16"	None	
12[R]		20004-06	1	1/2"	14"	3"	14"	3"	None	
13		20004-05	1	1/2"	8 1/16"	12 7/8"	8 1/16"	12 7/8"	None	
17[R]		20004-11	1	1/2"	23 5/8"	12"	23 5/8"	12"	None	

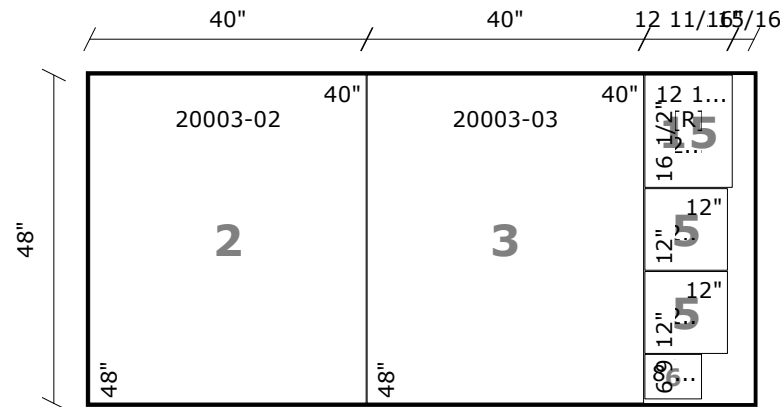

[B11] 15/32" (1/2") A/C or CDX Plywood: 1/2" x 48" x 96"

Vendor: Bin:

[] 11 of 12 this size

Qty this diag.: 1

Grain: None

Stock Trim: 0"::0"

Standard Layout

Kerf: 1/8"

Part Padding: 0"

Waste: 4.7%

Final Cut Dimensions

Part #	Sub-Assembly	Description	Copies in Layout	Thick	Final Cut Y	Final Cut X	Rough Y	Rough X	Banding	<Info>
2		20003-02	1	1/2"	48"	40"	48"	40"	None	
3		20003-03	1	1/2"	48"	40"	48"	40"	None	
5		20003-10	2	1/2"	12"	12"	12"	12"	None	
6		20004-25	1	1/2"	6 9/16"	8 1/4"	6 9/16"	8 1/4"	None	
15[R]		20004-08	1	1/2"	16 1/2"	12 11/16"	16 1/2"	12 11/16"	None	

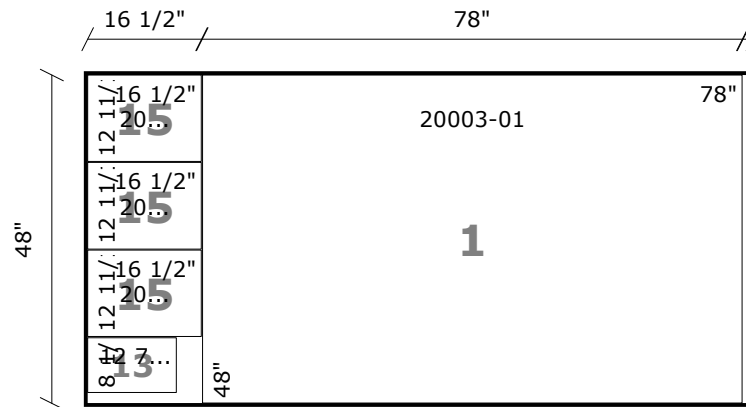

[B12] 15/32" (1/2") A/C or CDX Plywood: 1/2" x 48" x 96"

Vendor: Bin:

[] 12 of 12 this size

Qty this diag.: 1

Grain: None

Stock Trim: 0"::0"

Standard Layout

Kerf: 1/8"

Part Padding: 0"

Waste: 2.9%

Final Cut Dimensions

Part #	Sub-Assembly	Description	Copies in Layout	Thick	Final Cut Y	Final Cut X	Rough Y	Rough X	Banding	<Info>
1		20003-01	1	1/2"	48"	78"	48"	78"	None	
13		20004-05	1	1/2"	8 1/16"	12 7/8"	8 1/16"	12 7/8"	None	
15		20004-08	3	1/2"	12 11/16"	16 1/2"	12 11/16"	16 1/2"	None	

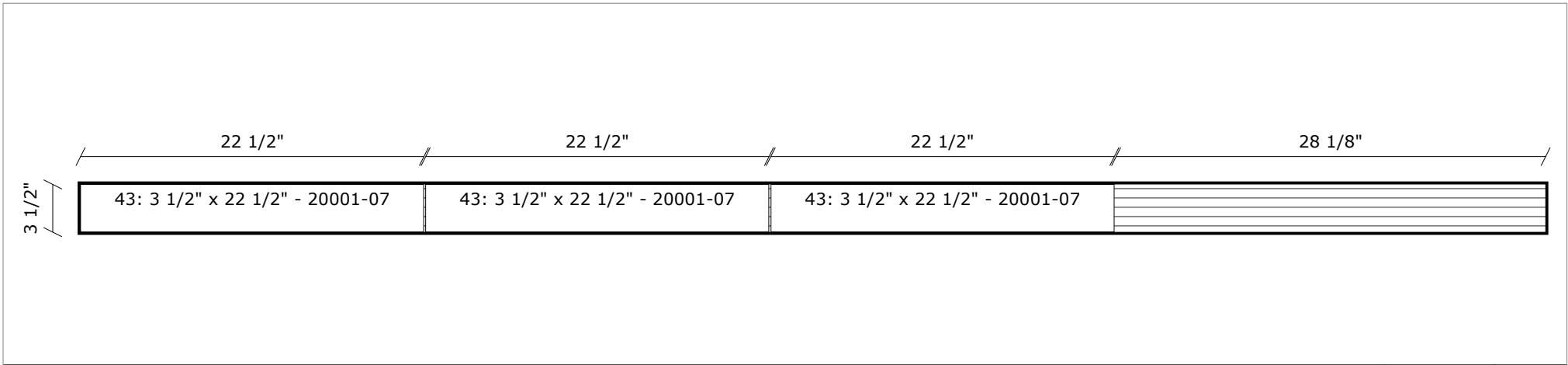

[C1] 2"x 4" Pine lumber: 9/4 x 4" (nom.) x 96"							Vendor:	Bin:
[] 1 of 21 this size				Qty this diag.: 1	Grain: Horizontal	Stock Trim: 0"::0"	Standard Layout	
Kerf: 1/8"		Part Padding: 0"		Waste: 29.7%			Final Cut Dimensions	

Part #	Sub-Assembly	Description	Copies in Layout	Thick	Final Cut Y	Final Cut X	Rough Y	Rough X	Banding	<Info>
43		20001-07	3	1 1/2"	3 1/2"	22 1/2"	3 1/2"	22 1/2"	N/A	

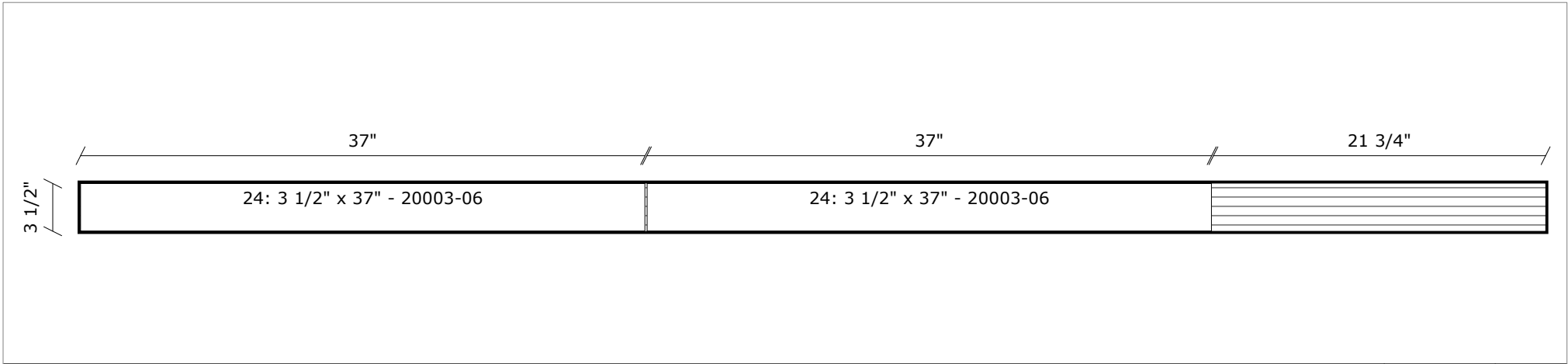

[C2] 2"x 4" Pine lumber: 9/4 x 4" (nom.) x 96"					Vendor:	Bin:
[] 2 of 21 this size			Qty this diag.: 2	Grain: Horizontal	Stock Trim: 0"::0"	Standard Layout
Kerf: 1/8"	Part Padding: 0"		Waste: 22.9%		Final Cut Dimensions	

Part #	Sub-Assembly	Description	Copies in Layout	Thick	Final Cut Y	Final Cut X	Rough Y	Rough X	Banding	<Info>
24		20003-06	2	1 1/2"	3 1/2"	37"	3 1/2"	37"	N/A	

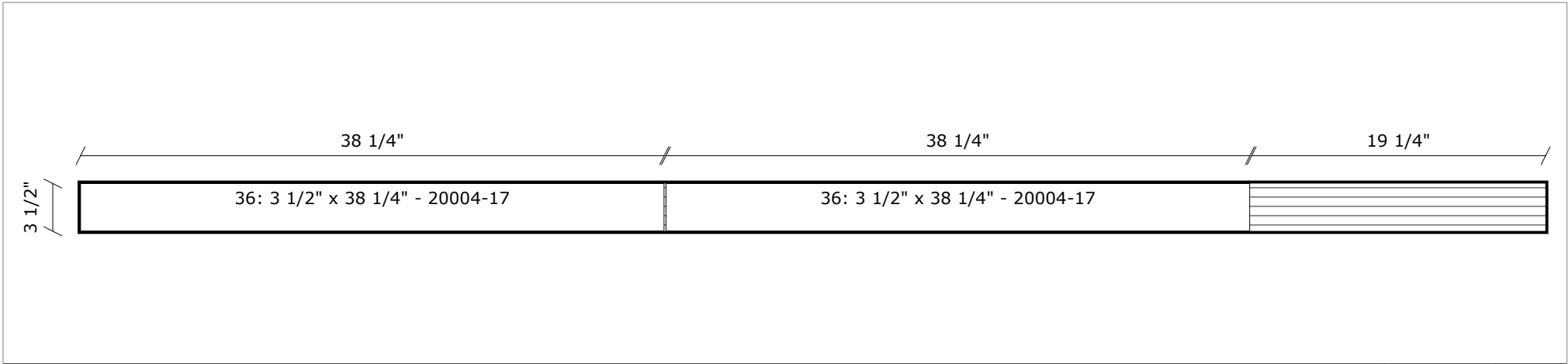

[C3] 2"x 4" Pine lumber: 9/4 x 4" (nom.) x 96"					Vendor:	Bin:
[] 3 of 21 this size			Qty this diag.: 1	Grain: Horizontal	Stock Trim: 0"::0"	Standard Layout
Kerf: 1/8"		Part Padding: 0"		Waste: 20.3%		Final Cut Dimensions

Part #	Sub-Assembly	Description	Copies in Layout	Thick	Final Cut Y	Final Cut X	Rough Y	Rough X	Banding	<Info>
36		20004-17	2	1 1/2"	3 1/2"	38 1/4"	3 1/2"	38 1/4"	N/A	

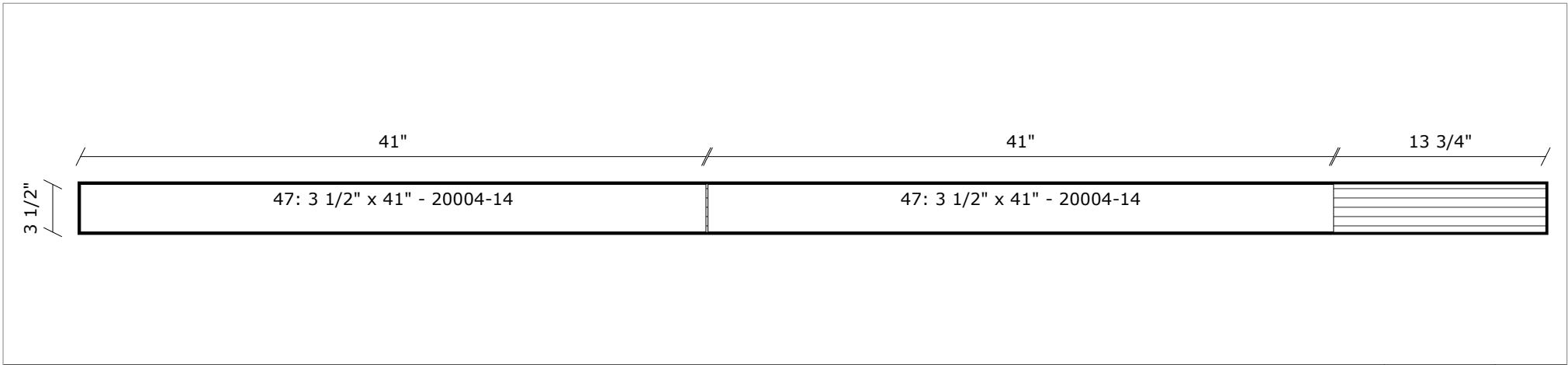

[C4] 2"x 4" Pine lumber: 9/4 x 4" (nom.) x 96"							Vendor:	Bin:
[] 4 of 21 this size				Qty this diag.: 1	Grain: Horizontal	Stock Trim: 0"::0"	Standard Layout	
Kerf: 1/8"		Part Padding: 0"		Waste: 14.6%			Final Cut Dimensions	

Part #	Sub-Assembly	Description	Copies in Layout	Thick	Final Cut Y	Final Cut X	Rough Y	Rough X	Banding	<Info>
47		20004-14	2	1 1/2"	3 1/2"	41"	3 1/2"	41"	N/A	

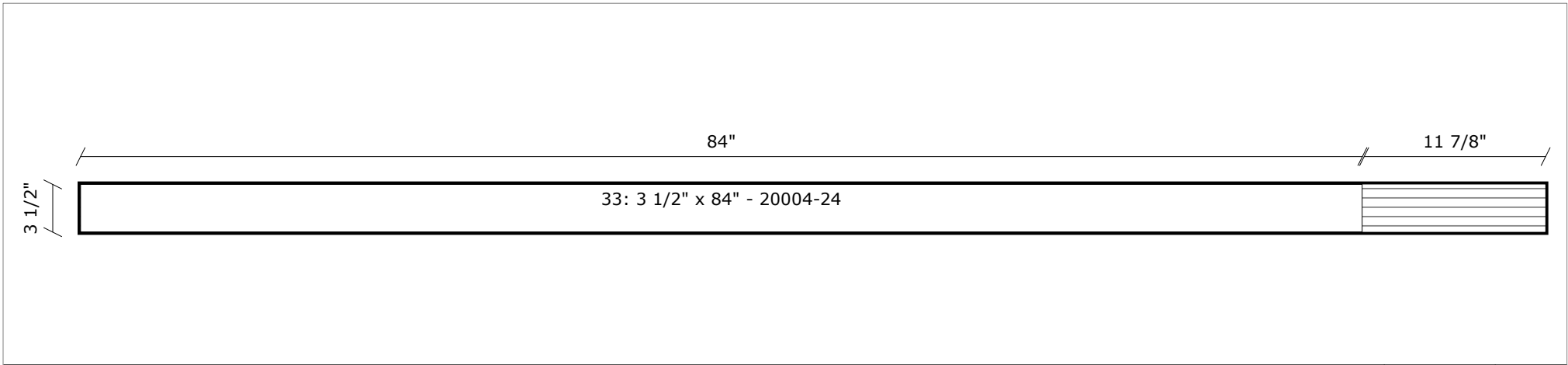

[C5] 2"x 4" Pine lumber: 9/4 x 4" (nom.) x 96"					Vendor:	Bin:
[] 5 of 21 this size			Qty this diag.: 2	Grain: Horizontal	Stock Trim: 0"::0"	Standard Layout
Kerf: 1/8"	Part Padding: 0"	Waste: 12.5%	Final Cut Dimensions			

Part #	Sub-Assembly	Description	Copies in Layout	Thick	Final Cut Y	Final Cut X	Rough Y	Rough X	Banding	<Info>
33		20004-24	1	1 1/2"	3 1/2"	84"	3 1/2"	84"	N/A	

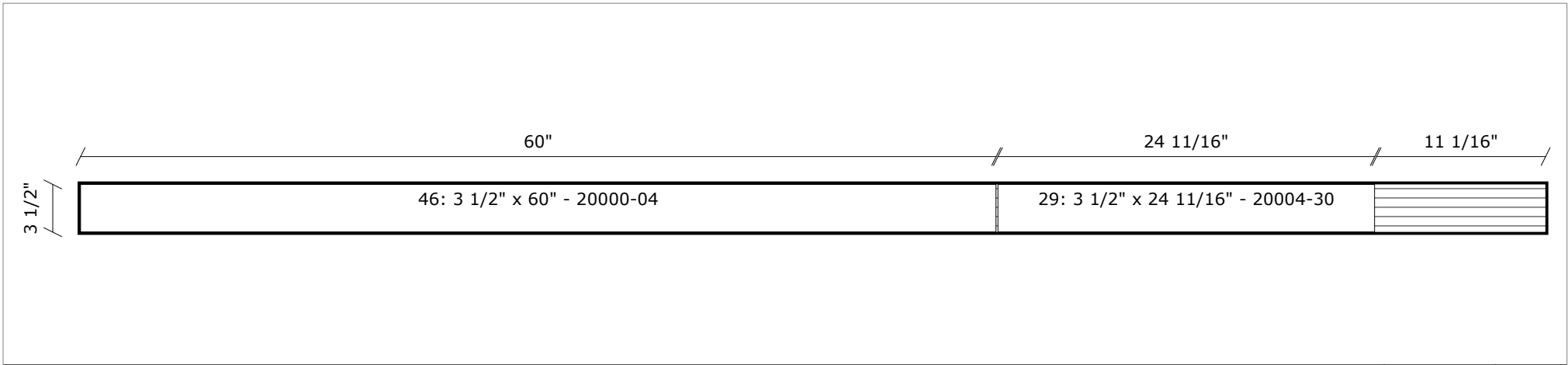

[C6] 2"x 4" Pine lumber: 9/4 x 4" (nom.) x 96"					Vendor:	Bin:
[] 6 of 21 this size			Qty this diag.: 1	Grain: Horizontal	Stock Trim: 0"::0"	Standard Layout
Kerf: 1/8"		Part Padding: 0"		Waste: 11.8%		Final Cut Dimensions

Part #	Sub-Assembly	Description	Copies in Layout	Thick	Final Cut Y	Final Cut X	Rough Y	Rough X	Banding	<Info>
29		20004-30	1	1 1/2"	3 1/2"	24 11/16"	3 1/2"	24 11/16"	N/A	
46		20000-04	1	1 1/2"	3 1/2"	60"	3 1/2"	60"	N/A	

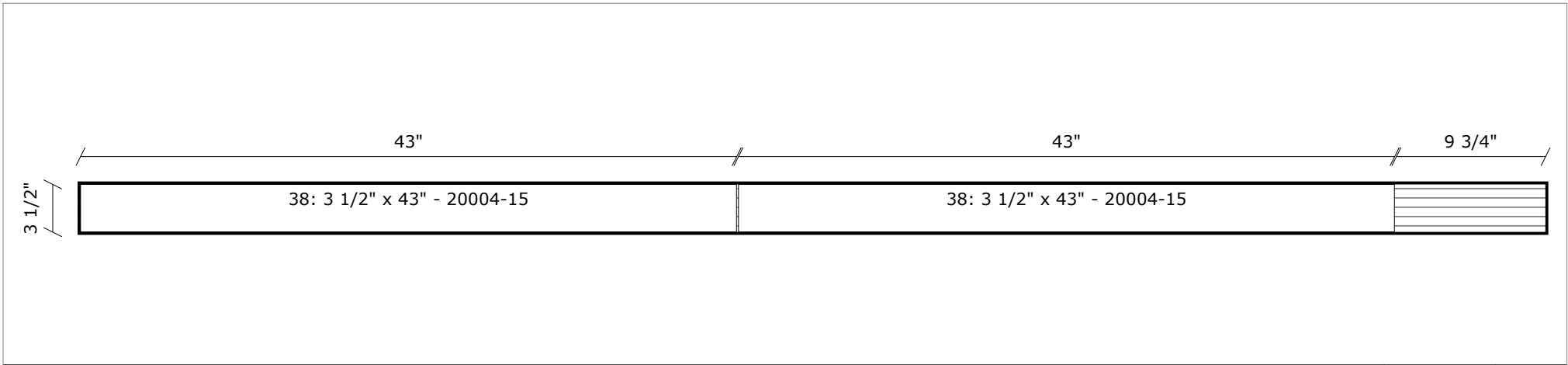

[C7] 2"x 4" Pine lumber: 9/4 x 4" (nom.) x 96"					Vendor:	Bin:
[] 7 of 21 this size			Qty this diag.: 1	Grain: Horizontal	Stock Trim: 0"::0"	Standard Layout
Kerf: 1/8"	Part Padding: 0"	Waste: 10.4%		Final Cut Dimensions		

Part #	Sub-Assembly	Description	Copies in Layout	Thick	Final Cut Y	Final Cut X	Rough Y	Rough X	Banding	<Info>
38		20004-15	2	1 1/2"	3 1/2"	43"	3 1/2"	43"	N/A	

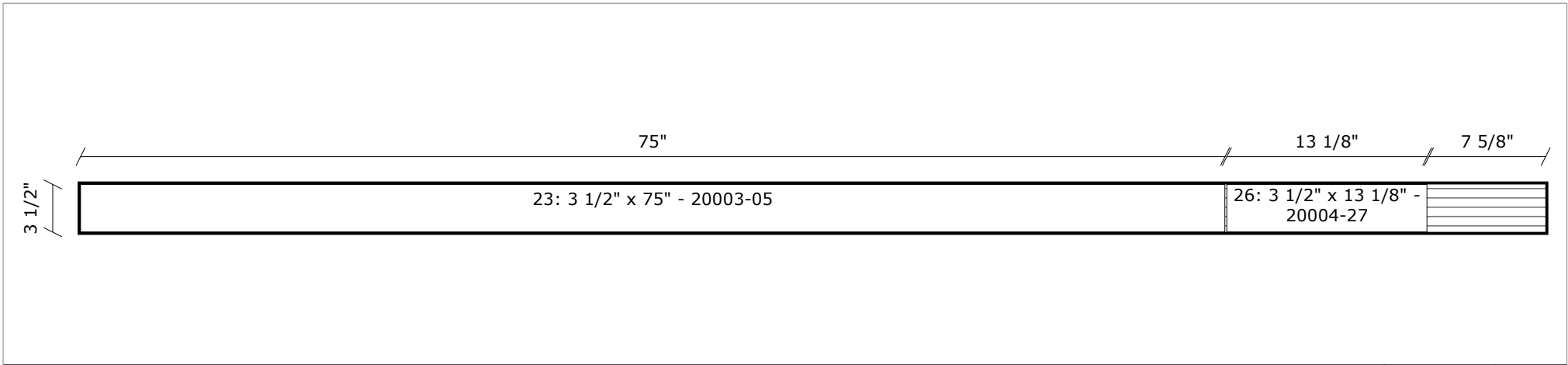

[C8] 2"x 4" Pine lumber: 9/4 x 4" (nom.) x 96"					Vendor:	Bin:
[] 8 of 21 this size			Qty this diag.: 4	Grain: Horizontal	Stock Trim: 0"::0"	Standard Layout
Kerf: 1/8"		Part Padding: 0"		Waste: 8.2%		Final Cut Dimensions

Part #	Sub-Assembly	Description	Copies in Layout	Thick	Final Cut Y	Final Cut X	Rough Y	Rough X	Banding	<Info>
23		20003-05	1	1 1/2"	3 1/2"	75"	3 1/2"	75"	N/A	
26		20004-27	1	1 1/2"	3 1/2"	13 1/8"	3 1/2"	13 1/8"	N/A	

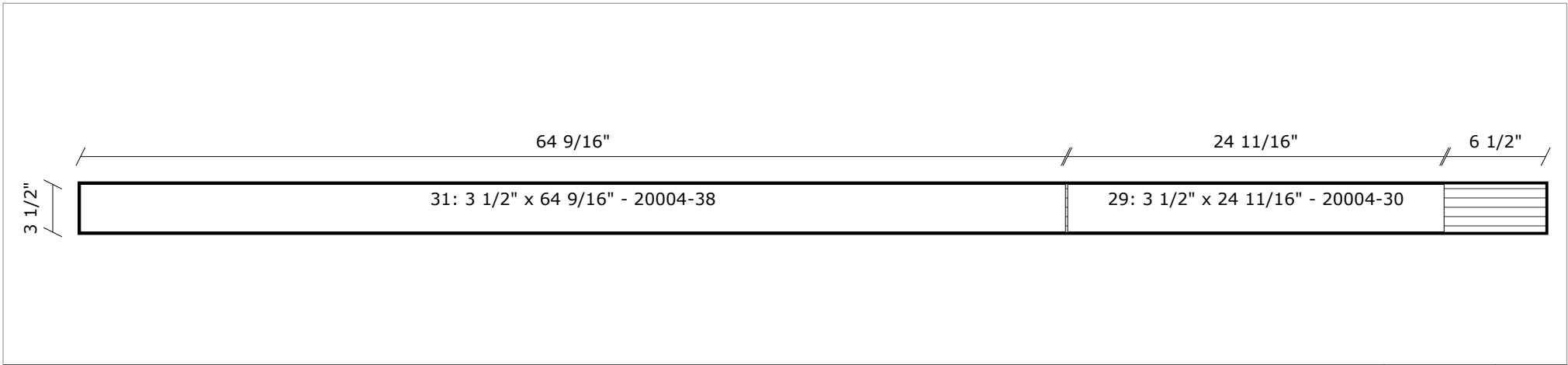

[C9] 2"x 4" Pine lumber: 9/4 x 4" (nom.) x 96"					Vendor:	Bin:
[] 9 of 21 this size			Qty this diag.: 2	Grain: Horizontal	Stock Trim: 0"::0"	Standard Layout
Kerf: 1/8"		Part Padding: 0"		Waste: 7.0%		Final Cut Dimensions

Part #	Sub-Assembly	Description	Copies in Layout	Thick	Final Cut Y	Final Cut X	Rough Y	Rough X	Banding	<Info>
29		20004-30	1	1 1/2"	3 1/2"	24 11/16"	3 1/2"	24 11/16"	N/A	
31		20004-38	1	1 1/2"	3 1/2"	64 9/16"	3 1/2"	64 9/16"	N/A	

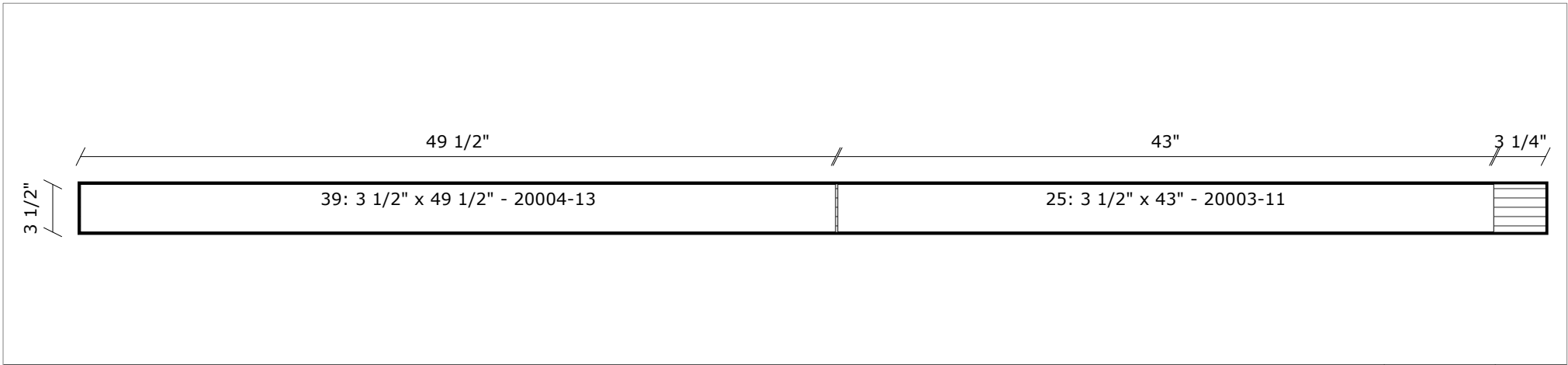

[C10] 2"x 4" Pine lumber: 9/4 x 4" (nom.) x 96"					Vendor:	Bin:
[] 10 of 21 this size			Qty this diag.: 2	Grain: Horizontal	Stock Trim: 0"::0"	Standard Layout
Kerf: 1/8"		Part Padding: 0"		Waste: 3.6%		Final Cut Dimensions

Part #	Sub-Assembly	Description	Copies in Layout	Thick	Final Cut Y	Final Cut X	Rough Y	Rough X	Banding	<Info>
25		20003-11	1	1 1/2"	3 1/2"	43"	3 1/2"	43"	N/A	
39		20004-13	1	1 1/2"	3 1/2"	49 1/2"	3 1/2"	49 1/2"	N/A	

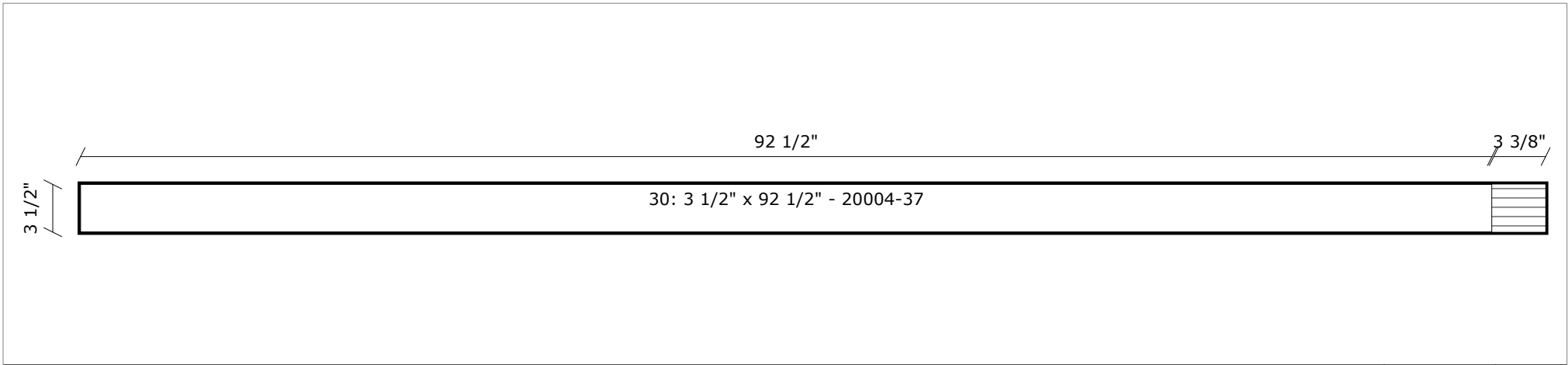

[C11] 2"x 4" Pine lumber: 9/4 x 4" (nom.) x 96"					Vendor:	Bin:
[] 11 of 21 this size			Qty this diag.: 4	Grain: Horizontal	Stock Trim: 0"::0"	Standard Layout
Kerf: 1/8"		Part Padding: 0"		Waste: 3.6%		Final Cut Dimensions

Part #	Sub-Assembly	Description	Copies in Layout	Thick	Final Cut Y	Final Cut X	Rough Y	Rough X	Banding	<Info>
30		20004-37	1	1 1/2"	3 1/2"	92 1/2"	3 1/2"	92 1/2"	N/A	

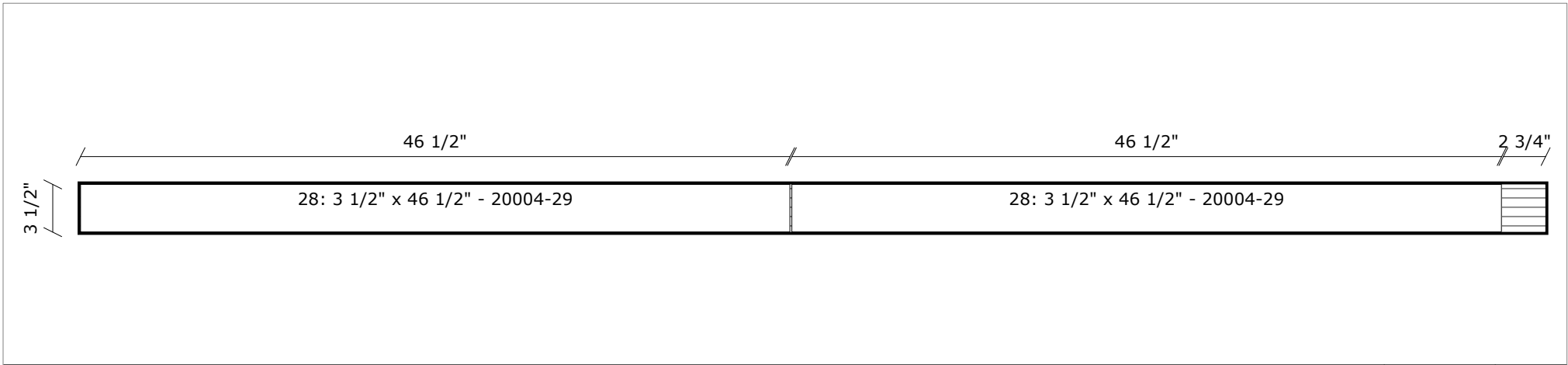

[C12] 2"x 4" Pine lumber: 9/4 x 4" (nom.) x 96"					Vendor:	Bin:
[] 12 of 21 this size			Qty this diag.: 2	Grain: Horizontal	Stock Trim: 0"::0"	Standard Layout
Kerf: 1/8"		Part Padding: 0"		Waste: 3.1%		Final Cut Dimensions

Part #	Sub-Assembly	Description	Copies in Layout	Thick	Final Cut Y	Final Cut X	Rough Y	Rough X	Banding	<Info>
28		20004-29	2	1 1/2"	3 1/2"	46 1/2"	3 1/2"	46 1/2"	N/A	

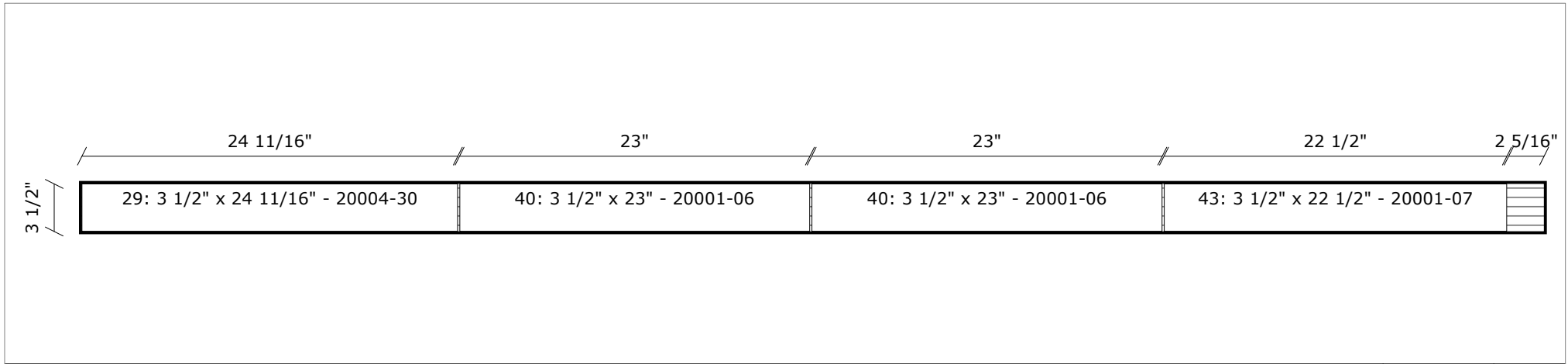

[C13] 2"x 4" Pine lumber: 9/4 x 4" (nom.) x 96"					Vendor:	Bin:
[] 13 of 21 this size			Qty this diag.: 1	Grain: Horizontal	Stock Trim: 0"::0"	Standard Layout
Kerf: 1/8"		Part Padding: 0"		Waste: 2.9%		Final Cut Dimensions

Part #	Sub-Assembly	Description	Copies in Layout	Thick	Final Cut Y	Final Cut X	Rough Y	Rough X	Banding	<Info>
29		20004-30	1	1 1/2"	3 1/2"	24 11/16"	3 1/2"	24 11/16"	N/A	
40		20001-06	2	1 1/2"	3 1/2"	23"	3 1/2"	23"	N/A	
43		20001-07	1	1 1/2"	3 1/2"	22 1/2"	3 1/2"	22 1/2"	N/A	

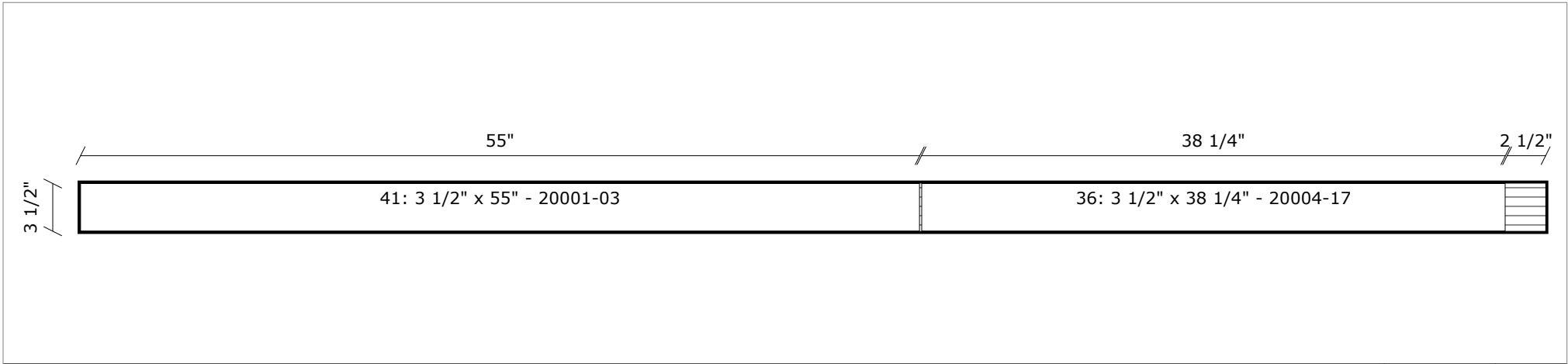

[C14] 2"x 4" Pine lumber: 9/4 x 4" (nom.) x 96"					Vendor:	Bin:
[] 14 of 21 this size			Qty this diag.: 2	Grain: Horizontal	Stock Trim: 0"::0"	Standard Layout
Kerf: 1/8"		Part Padding: 0"		Waste: 2.9%		Final Cut Dimensions

Part #	Sub-Assembly	Description	Copies in Layout	Thick	Final Cut Y	Final Cut X	Rough Y	Rough X	Banding	<Info>
36		20004-17	1	1 1/2"	3 1/2"	38 1/4"	3 1/2"	38 1/4"	N/A	
41		20001-03	1	1 1/2"	3 1/2"	55"	3 1/2"	55"	N/A	

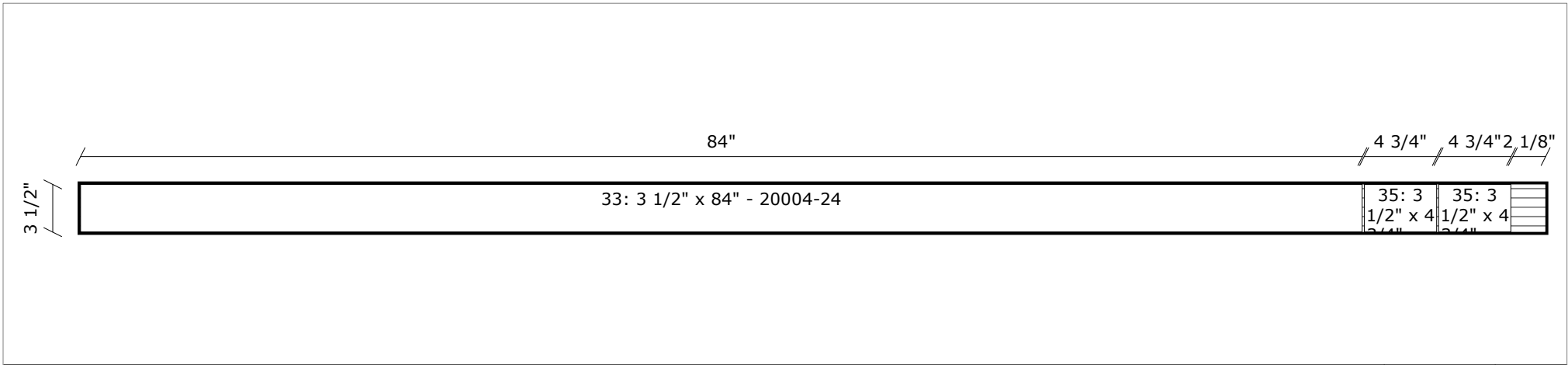

[C15] 2"x 4" Pine lumber: 9/4 x 4" (nom.) x 96"				Vendor:	Bin:
[] 15 of 21 this size		Qty this diag.: 2	Grain: Horizontal	Stock Trim: 0"::0"	Standard Layout
Kerf: 1/8"	Part Padding: 0"	Waste: 2.6%	Final Cut Dimensions		

Part #	Sub-Assembly	Description	Copies in Layout	Thick	Final Cut Y	Final Cut X	Rough Y	Rough X	Banding	<Info>
33		20004-24	1	1 1/2"	3 1/2"	84"	3 1/2"	84"	N/A	
35		20004-18	2	1 1/2"	3 1/2"	4 3/4"	3 1/2"	4 3/4"	N/A	

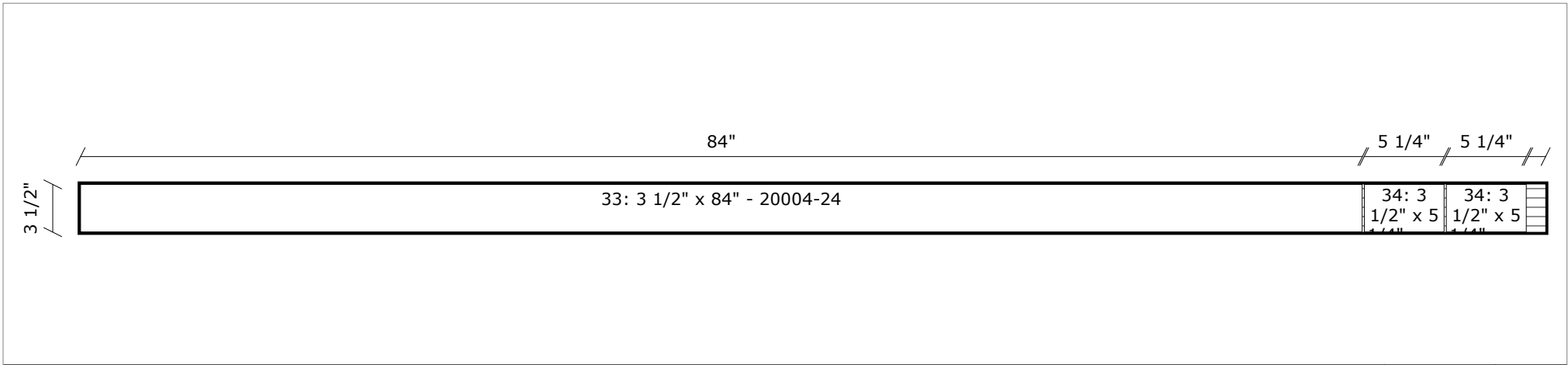

[C16] 2"x 4" Pine lumber: 9/4 x 4" (nom.) x 96"				Vendor:	Bin:
[] 16 of 21 this size		Qty this diag.: 2	Grain: Horizontal	Stock Trim: 0"::0"	Standard Layout
Kerf: 1/8"	Part Padding: 0"	Waste: 1.6%		Final Cut Dimensions	

Part #	Sub-Assembly	Description	Copies in Layout	Thick	Final Cut Y	Final Cut X	Rough Y	Rough X	Banding	<Info>
33		20004-24	1	1 1/2"	3 1/2"	84"	3 1/2"	84"	N/A	
34		20004-16	2	1 1/2"	3 1/2"	5 1/4"	3 1/2"	5 1/4"	N/A	

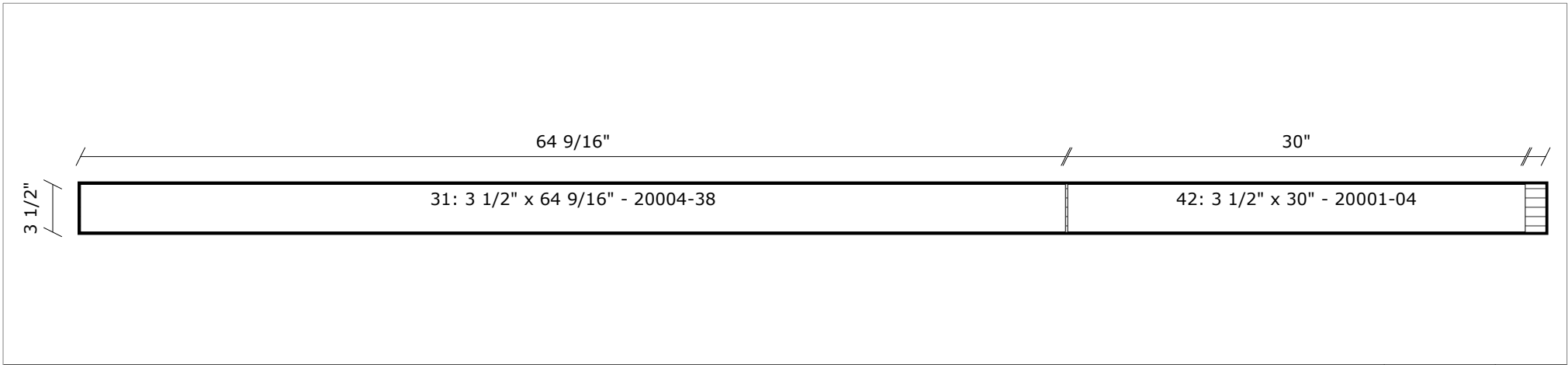

[C17] 2"x 4" Pine lumber: 9/4 x 4" (nom.) x 96"					Vendor:	Bin:
[] 17 of 21 this size			Qty this diag.: 2	Grain: Horizontal	Stock Trim: 0"::0"	Standard Layout
Kerf: 1/8"		Part Padding: 0"		Waste: 1.5%		Final Cut Dimensions

Part #	Sub-Assembly	Description	Copies in Layout	Thick	Final Cut Y	Final Cut X	Rough Y	Rough X	Banding	<Info>
31		20004-38	1	1 1/2"	3 1/2"	64 9/16"	3 1/2"	64 9/16"	N/A	
42		20001-04	1	1 1/2"	3 1/2"	30"	3 1/2"	30"	N/A	

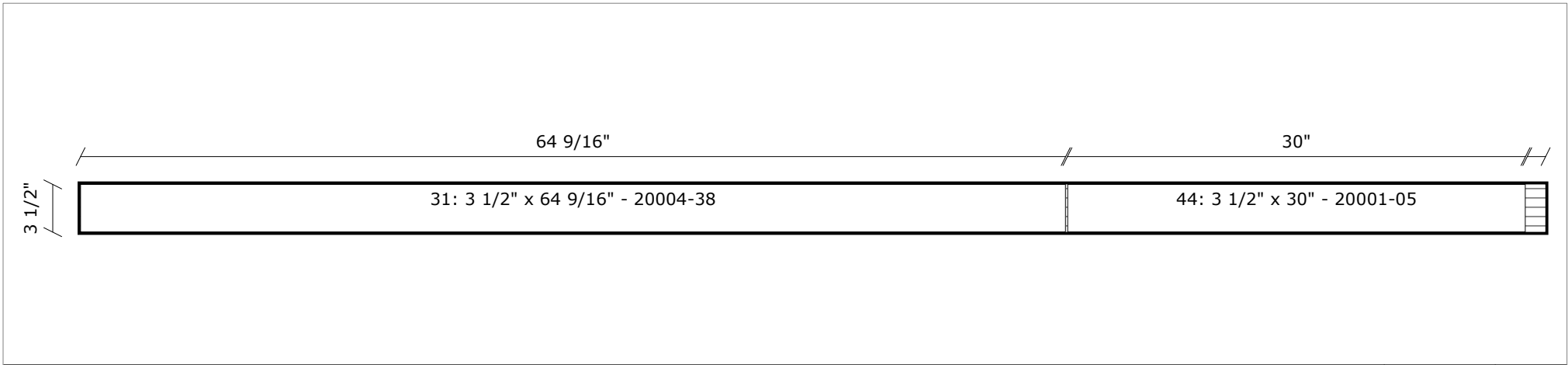

[C18] 2"x 4" Pine lumber: 9/4 x 4" (nom.) x 96"					Vendor:	Bin:
[] 18 of 21 this size			Qty this diag.: 4	Grain: Horizontal	Stock Trim: 0"::0"	Standard Layout
Kerf: 1/8"		Part Padding: 0"		Waste: 1.5%		Final Cut Dimensions

Part #	Sub-Assembly	Description	Copies in Layout	Thick	Final Cut Y	Final Cut X	Rough Y	Rough X	Banding	<Info>
31		20004-38	1	1 1/2"	3 1/2"	64 9/16"	3 1/2"	64 9/16"	N/A	
44		20001-05	1	1 1/2"	3 1/2"	30"	3 1/2"	30"	N/A	

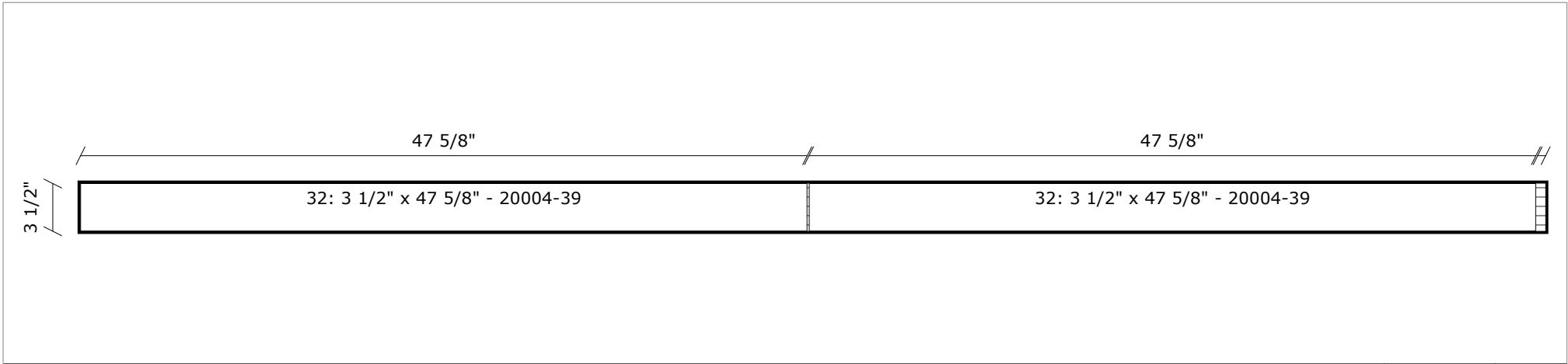

[C19] 2"x 4" Pine lumber: 9/4 x 4" (nom.) x 96"					Vendor:	Bin:
[] 19 of 21 this size			Qty this diag.: 2	Grain: Horizontal	Stock Trim: 0"::0"	Standard Layout
Kerf: 1/8"	Part Padding: 0"	Waste: 0.8%		Final Cut Dimensions		

Part #	Sub-Assembly	Description	Copies in Layout	Thick	Final Cut Y	Final Cut X	Rough Y	Rough X	Banding	<Info>
32		20004-39	2	1 1/2"	3 1/2"	47 5/8"	3 1/2"	47 5/8"	N/A	

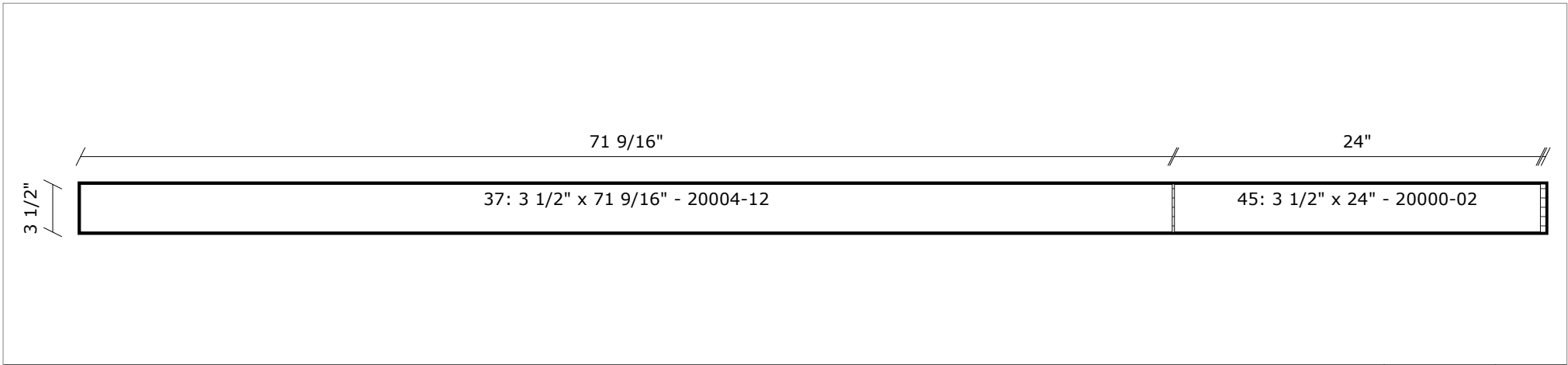

[C20] 2"x 4" Pine lumber: 9/4 x 4" (nom.) x 96"					Vendor:	Bin:
[] 20 of 21 this size			Qty this diag.: 4	Grain: Horizontal	Stock Trim: 0"::0"	Standard Layout
Kerf: 1/8"		Part Padding: 0"		Waste: 0.5%		Final Cut Dimensions

Part #	Sub-Assembly	Description	Copies in Layout	Thick	Final Cut Y	Final Cut X	Rough Y	Rough X	Banding	<Info>
37		20004-12	1	1 1/2"	3 1/2"	71 9/16"	3 1/2"	71 9/16"	N/A	
45		20000-02	1	1 1/2"	3 1/2"	24"	3 1/2"	24"	N/A	

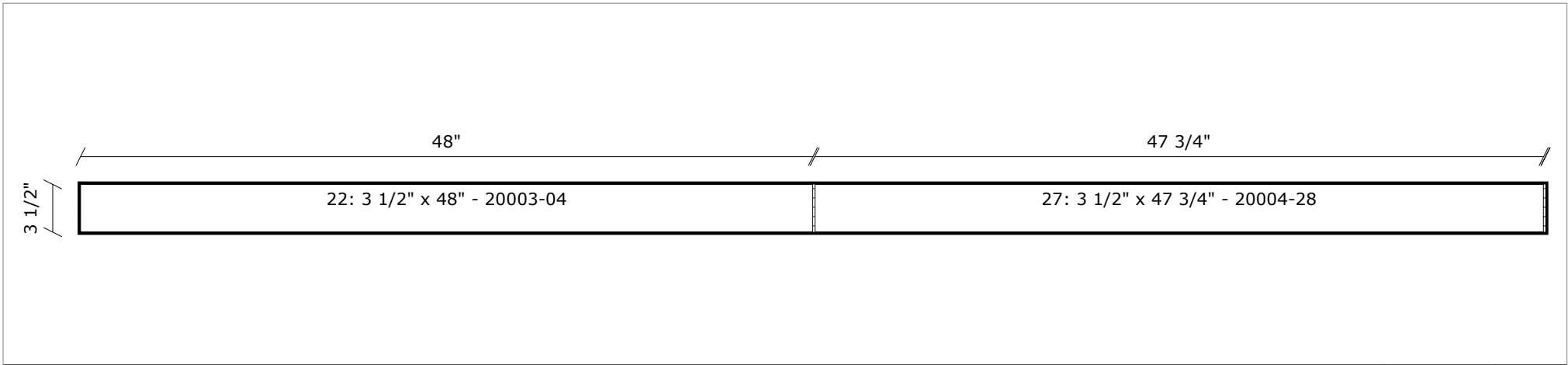

[C21] 2"x 4" Pine lumber: 9/4 x 4" (nom.) x 96"					Vendor:	Bin:
[] 21 of 21 this size			Qty this diag.: 8	Grain: Horizontal	Stock Trim: 0"::0"	Standard Layout
Kerf: 1/8"		Part Padding: 0"		Waste: 0.3%		Final Cut Dimensions

Part #	Sub-Assembly	Description	Copies in Layout	Thick	Final Cut Y	Final Cut X	Rough Y	Rough X	Banding	<Info>
22		20003-04	1	1 1/2"	3 1/2"	48"	3 1/2"	48"	N/A	
27		20004-28	1	1 1/2"	3 1/2"	47 3/4"	3 1/2"	47 3/4"	N/A	

Bill of Materials

Cost Summary

Item	Amount
Rough Lumber	\$0.00
Dimensioned Lumber	\$169.50
Sheet Goods	\$368.07
Edge Banding	\$0.00
Other Items	\$0.00
Labor Costs (0.0 hours)	\$0.00
Project Total	\$537.57

Dimensioned Lumber

<input type="checkbox"/>	Material Name	Nominal Size	Actual Width	Nom. Width	Length	Unit Cost	Units	Quantity	From Inv.	To Buy	Total Cost	Vendor	Bin
<input checked="" type="checkbox"/>	2"x 4" Pine lumber	9/4	3 1/2"	4"	96"	\$3.39	Boards	50	50	0	\$169.50		

Sheet Goods

<input type="checkbox"/>	Material Name	Thick	Width	Length	Unit Cost	Units	Quantity	From Inv.	To Buy	Total Cost	Vendor	Bin
<input checked="" type="checkbox"/>	1/4" Plywood	1/4"	48"	96"	\$24.99	Sheets	1	1	0	\$24.99		
<input checked="" type="checkbox"/>	15/32" (1/2") A/C or CDX Plywood	1/2"	48"	96"	\$28.59	Sheets	12	12	0	\$343.08		

Pricing Summary

Cost	Markup	Pct Markup	Price	Pct Total
------	--------	------------	-------	-----------

This feature is available in the Gold Edition.